

**MasterMover®**

Compact solutions  
to safely and efficiently  
move heavy loads

Electric Tug Solutions





# Discover safer material handling

Streamline your material handling processes with our electric tugs and tows. Designed to deliver the safe, controlled movement of loads 70,000kg and beyond, businesses across industrial manufacturing, retail and logistics trust MasterMover electric tugs to improve safety and efficiency.

Eliminating manual handling and reducing the risk of injuries in the movement of loads, our electric tugs empower a single operator to move heavy loads with complete confidence.

Boasting innovative designs, electric tugs enable the seamless movement of loads in the tightest of spaces, delivering maximum manoeuvrability and control. An effective alternative to traditional material handling equipment, electric tugs do not require a license to operate, driving operational efficiency and productivity.

# What is an electric tug?



Electric tugs are a type of material handling equipment designed to move heavy-wheeled loads.

## How do they work?

Featuring a license-free operation, electric tugs keep loads safely on the ground. They utilise two key methods to generate traction and in turn, the ability to move heavy loads.

## How are they powered?

Electric tugs are 100% battery powered with multiple options available depending on your requirements. Options range from interchangeable maintenance-free battery systems to lithium options for high-intensity environments.

## What types are available?

Electric tugs are available as pedestrian operated, remote control or even as fully autonomous solutions (AGV).

## How to they connect to a load?

Electric tugs are available with a range of coupling options to achieve a safe, secure and robust connection between the machine and the load.

# The benefits of electric tugs



## Improve safety

Eliminate manual handling and reduce reliance on cranes and forklifts



## Maximise efficiency

Boost labour productivity and efficiency

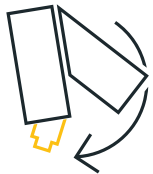

## Unrivalled control

Maximum control in the hands of single operators



## Zero emissions

Supporting sustainability and net-carbon targets

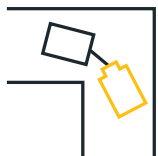

## Manoeuvrability

Push, pull and manoeuvre with ease, even in tight spaces



## Weight capacity

Move loads of 70,000kg and beyond



# The use of electric tugs

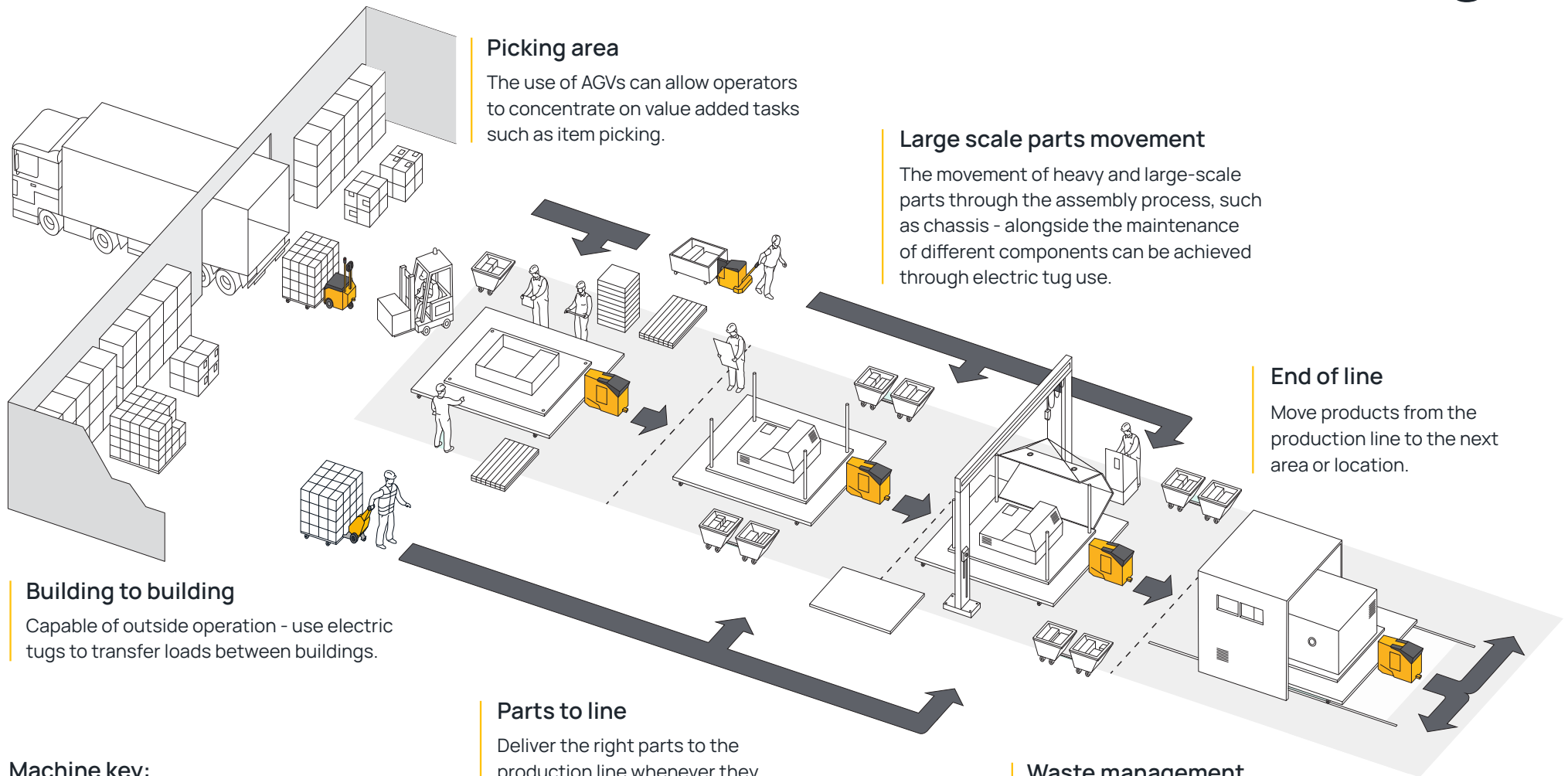

## Picking area

The use of AGVs can allow operators to concentrate on value added tasks such as item picking.

## Large scale parts movement

The movement of heavy and large-scale parts through the assembly process, such as chassis - alongside the maintenance of different components can be achieved through electric tug use.

## End of line

Move products from the production line to the next area or location.

## Building to building

Capable of outside operation - use electric tugs to transfer loads between buildings.

## Parts to line

Deliver the right parts to the production line whenever they are needed.

## Waste management

Remove waste materials away from the production line for processing with an automated guided vehicle for better utilisation of people.

### Machine key:



SmartMover



MasterTow AGV



MasterTug



PowerSteered

Product Range

# SmartMover



Up to 2,000kg





# Small but powerful electric tugs to eliminate manual handling

Easily move wheeled loads weighing up to 2,000kg with the SmartMover range. Delivering effortless pushing, pulling and steering, the SmartMover improves safety, removes manual handling and drives operational efficiency.

Benefit from versatility with various coupling options available, including a hydraulic clamp that delivers total load security.

## SmartMover Range

Machine model	Maximum load (on castors   on rails)	Maximum distance (per charge)	Charge time (external charger)
SM100 TOW	500 kg   2,000 kg	15.1 km	4 hrs 30 mins
LM100	1,000 kg   4,000 kg	9.3 km	4 hrs 30 mins
SM100+	1,200 kg   4,800 kg	7.7 km	4 hrs 30 mins
SM200+	2,000 kg   8,000 kg	4.2 km	5 hrs 30 mins





Product Range

# MasterTug



Up to 20,000kg





# Compact and powerful electric tugs for maximum control

The MasterTug range delivers unrivalled manoeuvrability when moving heavy-wheeled loads weighing up to 20,000kg. Utilising a unique weight transfer principle, the MasterTug range can move heavy weights whilst retaining an incredibly compact machine footprint. The design makes the MasterTug range perfect for working in confined spaces and facilitating precise movements.

The powerful performance of the MasterTug allows operators to push, pull and steer loads inside, outside and on slopes with complete control.

## MasterTug Range

Machine model	Maximum load (on castors   on rails)	Maximum distance (per charge)	Charge time (external charger)
MT200	2,000 kg   8,000 kg	10.6 km	3 hrs 45 mins
MT300+	3,000 kg   12,000 kg	11.7 km	5 hrs
MT400+	4,000 kg   16,000 kg	12.2 km	7 hrs
MT600+	6,000 kg   24,000 kg	8.4 km	7 hrs
MT800+	8,000 kg   32,000 kg	11.7 km	6 hrs
MT1000+	10,000 kg   40,000 kg	9.5 km	6 hrs
MT1200+	12,000 kg   48,000 kg	8 km	6 hrs
MT1500+	15,000 kg   60,000 kg	6.5 km	9 hrs
MT2000+	20,000 kg   80,000 kg	5.1 km	7 hrs





Product Range

# MasterTow



Up to 20,000kg

aircamo



# Easy-to-use electric tows to improve safety

Powerful electric tow tugs to effortlessly move up to 20,000kg with total control, with pedestrian operated, remote control and automated options available.

The MasterTow range of electric tow tugs, is ideally suited to towing loads weighing up to 20,000kg. The range uses its own weight to deliver consistent traction, enabling the effortless movement of loads both inside, outside and on slopes.

The MasterTow range is available with Remote Control, for maximum operator visibility, and Autonomous (AGV) solutions for maximum ROI, safety and efficiency.

## MasterTow Range

Machine model	Maximum load (on castors   on rails)	Maximum distance (per charge)	Charge time (external charger)
TOW200	2,000 kg   8,000 kg	16.6 km	5 hrs 30 mins
TOW300	3,000 kg   12,000 kg	11.8 km	5 hrs 30 mins
TOW600	6,000 kg   24,000 kg	8.5 km	7 hrs 30 mins
TOW600 ES	6,000 kg   24,000 kg	8.5 km	7 hrs 30 mins
TOW800 ES	8,000 kg   32,000 kg	6.5 km	8 hrs 30 mins
TOW1000 ES	10,000 kg   40,000 kg	10.2 km	7 hrs 30 mins
TOW1200 ES	12,000 kg   48,000 kg	8.6 km	7 hrs 30 mins
TOW1500 ES	15,000 kg   60,000 kg	6.9 km	7 hrs 30 mins
TOW2000 ES	20,000 kg   80,000 kg	5.9 km	8 hrs 30 mins





Product Range

# PowerSteered



Up to 70,000kg





# Fingertip control of heavy loads

The PowerSteered range allows a single operator to move loads with fingertip control for effortless movement. Benefit from intuitive power steering to make light work of moving the heaviest loads to drive safer, more efficient operations. The range is available with unparalleled control options, offering a solution for every heavy load-moving challenge. Choose from pedestrian-operated, remote control and even fully autonomous AGV options for maximum efficiency.

The robust design of the PowerSteered range guarantees unrivalled weight-moving performance. A secure coupling system ensures a rigid connection to the load, and a compact machine footprint delivers excellent manoeuvrability. Our PowerSteered electric tugs can be equipped with MultiLink technology, allowing multiple tugs to operate in unison under a single operator's control, providing combined weight-moving performance and enhanced steering capabilities

## PowerSteered Range

Machine model	Maximum load (on castors   on rails)	Maximum distance (per charge)	Charge time (external charger)
PS800+ LH	8,000 kg   32,000 kg	11.7 km	8 hrs
PS800+	8,000 kg   32,000 kg	13.5 km	8 hrs 30 mins
PS1000+	10,000 kg   40,000 kg	11.1 km	8 hrs 30 mins
PS1200+	12,000 kg   48,000 kg	9.4 km	8 hrs 30 mins
PS1500+	15,000 kg   60,000 kg	7.7 km	8 hrs 30 mins
PS2000+	20,000 kg   80,000 kg	5.9 km	8 hrs 30 mins
PS2500+	25,000 kg   100,000 kg	4.8 km	8 hrs 30 mins
PS3000+	30,000 kg   120,000 kg	4 km	6 hrs
PS7000+	70,000 kg   280,000 kg	5 km	8 hrs

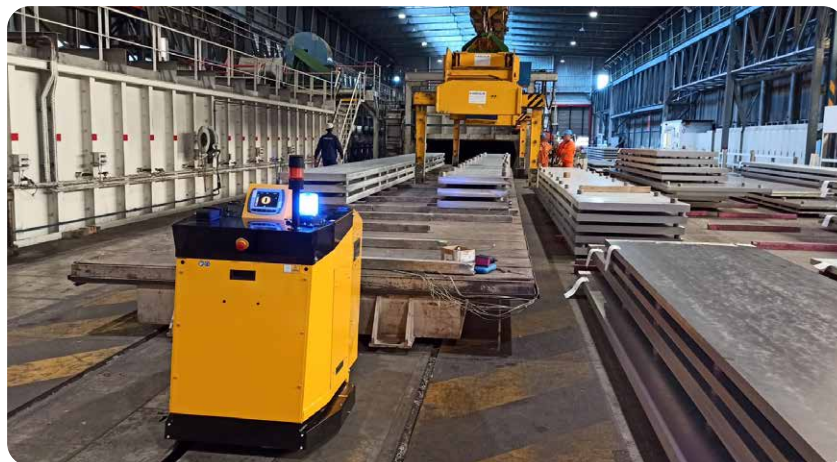

Product Range

# AllTerrain



Up to 5,000kg





# Powerful performance in the most challenging environments

The AllTerrain range enables the safe movement of heavy-wheeled loads weighing up to 5,000kg. Featuring an intuitive design, this range enables a single operator to easily push and pull loads with zero physical effort. With a design focused on durability and performance even in tough environments, the AllTerrain range can work outside on rough flooring and on slopes.

An optional remote control system is available to improve visibility and ease of pushing and pulling heavy loads during linear movements.

## AllTerrain Range

Machine model	Maximum load (on castors   on rails)	Maximum distance (per charge)	Charge time (external charger)
ATT400+	5,000 kg   40,000 kg	12.1 km	8 hrs 15 mins
ATP400	5,000 kg   80,000 kg	12.1 km	8 hrs 15 mins
MP400	5,000 kg   80,000 kg	13.4 km	7 hrs 30 mins

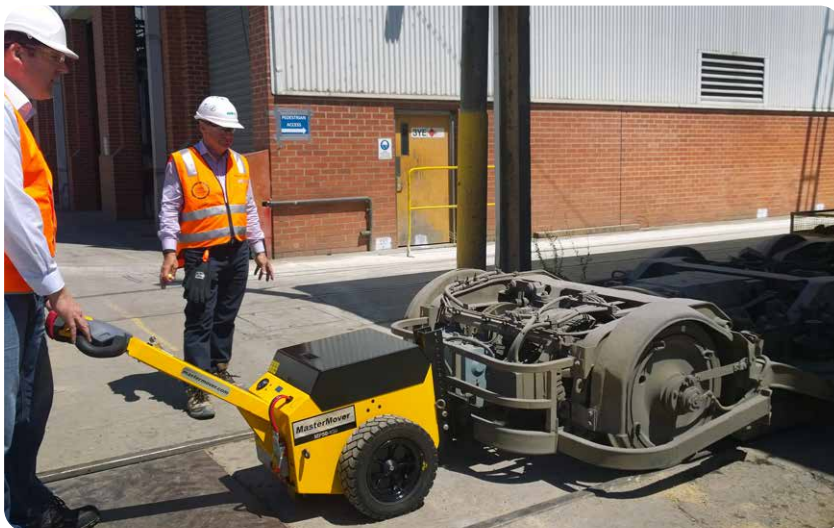

Product Range

# Trailer Moving System



Up to 20,000kg





# Safe and efficient movement of trailers

The Trailer Moving System is specifically designed to move unladen trailers weighing up to 20,000kg. From articulated trailers to flat beds and low loaders, the TMS range of electric tugs allow the effortless movement of heavy trailers inside, outside and on slopes. Fully electric and license-free, the Trailer Moving System prevents bottlenecks in moving trailers for both distribution depots and manufacturers alike.

Featuring a universal kingpin connection, the Trailer Moving System connects securely to any commercial trailer.

## Trailer Moving System Range

Machine model	Maximum load (on castors   on rails)	Maximum distance (per charge)	Charge time (external charger)
TMS1100+	11,000 kg   44,000 kg	8.4 km	6 hrs
TMS2000+	20,000 kg   80,000 kg	6.3 km	6 hrs

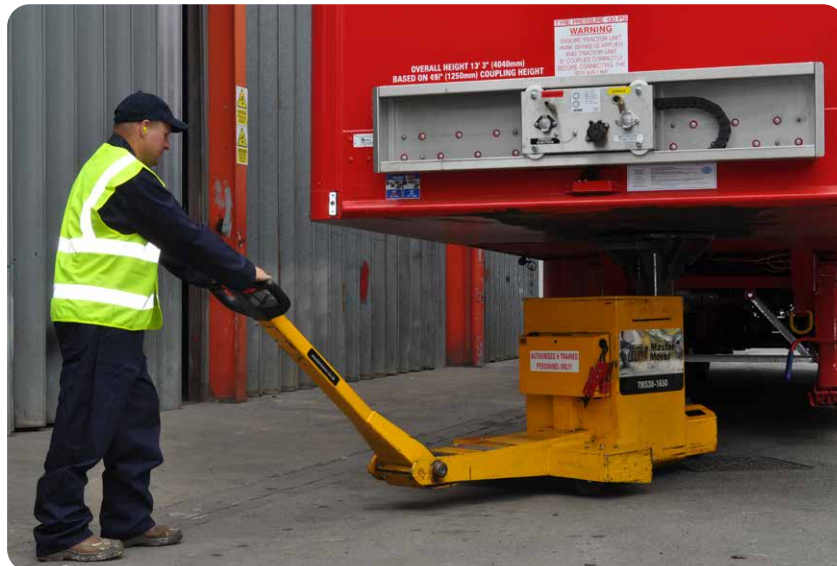





# Maximum manoeuvrability of all-swivelling loads

The MasterHandler range is specifically designed to deliver the controlled movement of loads weighing up to 4,000kg that are fitted with all-swivelling castors.

Featuring a unique design centred around delivering maximum control, the MasterHandler enables operators to easily steer and position heavy loads that ordinarily would be difficult to move in a controlled way.

With adjustable support legs available to deliver a controlled fixed point, the MasterHandler can provide a turnkey solution to the movement of loads with all swivelling castors.

## MasterHandler Range

Machine model	Maximum load (on castors   on rails)	Maximum distance (per charge)	Charge time (external charger)
MH400+	4,000 kg   16,000 kg	9.2 km	5 hrs 30 mins





Product Range

# Stainless Steel



Up to 15,000kg



# Compact, stainless steel solutions to maximise safety

The Stainless Steel range of electric tugs delivers the same level of performance as our mild steel ranges, but with the added benefit of seamlessly integrating into sterile environments.

Whether it's a biopharmaceutical cleanroom suite or a food manufacturing facility, our stainless steel electric tugs remove manual handling and drive operational efficiency without compromising the cleanliness of your facility.

Constructed from high-grade 316 stainless steel and with IP ratings of up to IP55 available, stainless steel electric tugs are ideally suited to the stringent requirements of sterile environments. You're guaranteed powerful performance with machines in the range capable of moving up to 15,000kg.



## Stainless Steel Range



Machine model	Maximum load (on castors   on rails)	Maximum distance (per charge)	Charge time (external charger)
SM100+ SS	1,200 kg   4,800 kg	7.7 km	4 hrs 30 mins
SM200+ SS	2,000 kg   8,000 kg	5.3 km	7 hrs
TOW200 SS	2,000 kg   8,000 kg	16.6 km	5 hrs 30 mins
TOW300 SS	3,000 kg   12,000 kg	11.8 km	5 hrs 30 mins
MH400+ SS	4,000 kg   16,000 kg	9.2 km	5 hrs 30 mins
MT5/400+ SS	4,000 kg   16,000 kg	12.4 km	8 hrs 15 mins
MT20/800+ SS	8,000 kg   32,000 kg	11.7 km	6 hrs
MT20/960+ SS	10,000 kg   40,000 kg	9.5 km	6 hrs
MT20/1200+ SS	12,000 kg   48,000 kg	8 km	6 hrs
MT20/1500+ SS	15,000 kg   60,000 kg	6.5 km	6 hrs





Product Range

# Automated Guided Vehicles





# Autonomous Load Moving Solutions

Automated Guided Vehicles (AGVs) have the ability to be transformational when it comes to driving operational efficiency within industrial manufacturing.

Featuring best-in-class navigation and safety technologies, AGVs remove the need for human operation, carrying out movement of products, equipment and materials on time, every time.

In addition, people are protected from manual handling injuries, and can spend more of their time on greater value adding and important tasks.

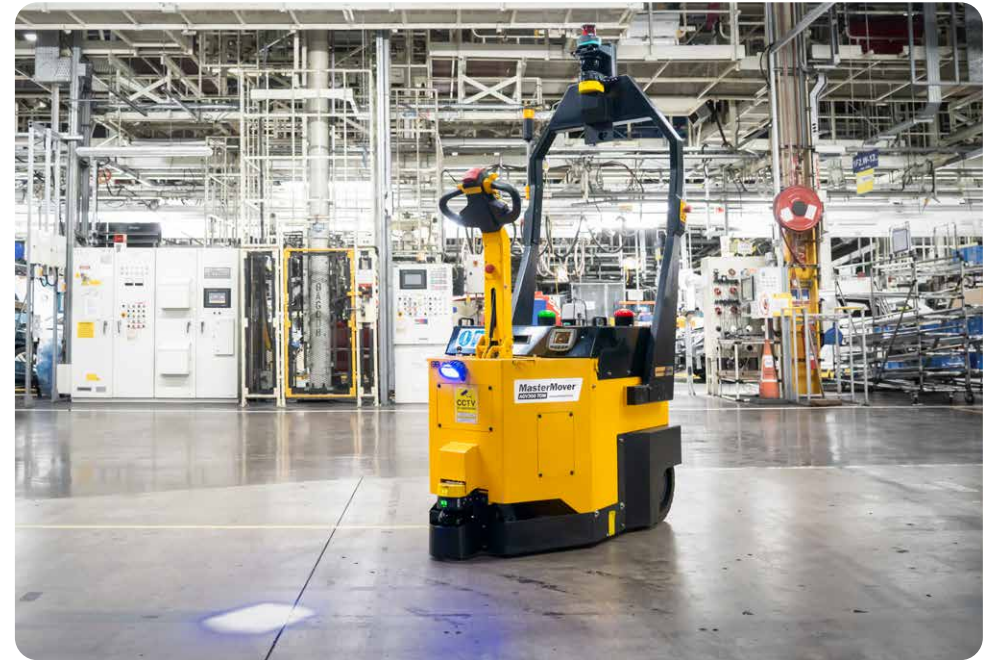

## Our AGV Range



**MasterTow AGV**

Weight capacity: Up to 20,000kg

Type: Towing AGV



**MasterHandler AGV**

Weight capacity: Up to 6,000kg

Type: Tugger AGV



**FlatBed AGV**

Weight capacity: 10,000kg plus

Type: Unit Load AGV



**PowerSteered AGV**

Weight capacity: 70,000kg

Type: Heavy Duty Tugger AGV



**Custom Solutions**

Weight capacity: Custom

Type: Custom

# The benefits of AGV technology



## Maximum safety

AGVs detect hazards and dangers, taking the appropriate action.



## No human error

AGVs eliminate human error, stopping the AGV in its tracks when risks are detected.



## 24/7 operation

With spare batteries and multi-charging options, AGVs can operate 24/7 helping to keep environments safe.



## Better efficiency

AGVs carry out tasks on time and at the optimal speed, faster than if done manually.

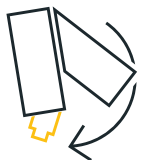

## Repeatable precision

AGVs guarantee repeated movement and precision – crucial in manufacturing to make the environment safe.



## Better use of people

AGVs do the heavy manual work and deliver greater ROI through staff spending more time doing greater-value tasks.





## Case Study

# AGV drives efficiency for Toyota Motor Manufacturing

### Before

- Tow tractor driver transporting resin back doors back & forth
- Inefficient use of resources
- A non-value adding task in lean manufacturing

### After

- TOW300 AGV now fully automates the process
- 24/7 operation and integrates with production systems
- Increased efficiency and better use of people



Industries

# Aerospace





# Precise movement of high-value loads

Global aerospace manufacturers and MRO providers trust MasterMover electric tugs to provide total control in the movement of high-value, heavy loads.

Whether it's in the production of aerostructures, the maintenance of aero engines, or moving sensitive loads in defence manufacturing, our electric tugs maximise control and manoeuvrability.

## Typical applications:

- Aerostructures & Composites
- Platforms & Staging
- Aero engines
- Jigs & tooling

## Benefits for the aerospace industry



Improve workplace safety



Precise movements



Unlock greater efficiency



Maximum control





Industries

# Automotive & Heavy Plant





# Creating leaner processes to accelerate efficiency

Automotive and heavy plant machinery manufacturers use MasterMover electric tugs to enhance lean processes and increase shop floor flexibility.

Whether it's in the lineside delivery of parts or the transfer of heavy sub-assemblies, electric tugs maximise production efficiency and reduce downtime.

## Typical applications:

- Body-in-whites
- Powertrains
- Sub-assemblies
- Press tools & moulds

## Benefits for automotive & heavy plant



Improve workplace safety



Just-in-time movements



Drive efficiency



Maximum control



Industries

# Energy & Petrochemical





# Scalable solutions for the future of energy



Material handling equipment in the energy industry needs to be able to work in some of the most challenging environments.

Electric tugs reduce the risk of accidents and deliver maximum manoeuvrability even in hazardous environments. Delivering safe, controlled movements across wind, oil and nuclear.

## Typical applications:

- Subsea trees
- Wind turbine blades
- Bearings & tooling
- Pipes & pumps

## Benefits for the energy industry



Maximum control



Improved safety



Greater flexibility



Zero emissions





Industries

# Facilities & Waste





# Supercharge staff safety in facilities management

Electric tugs eliminate manual handling, improve workplace safety and boost productivity in facilities management.

Delivering the safe movement of wheeled loads such as waste bins, roll cages and linen trolleys, electric tugs reduce the risk of staff injuries by eliminating manual handling.

## Typical applications:

- Roll cages
- Waste bins
- Food containers
- Linen trolleys

## Benefits for facilities management



Eliminate manual handling



Improved safety



Boost productivity



Reduce staff absence

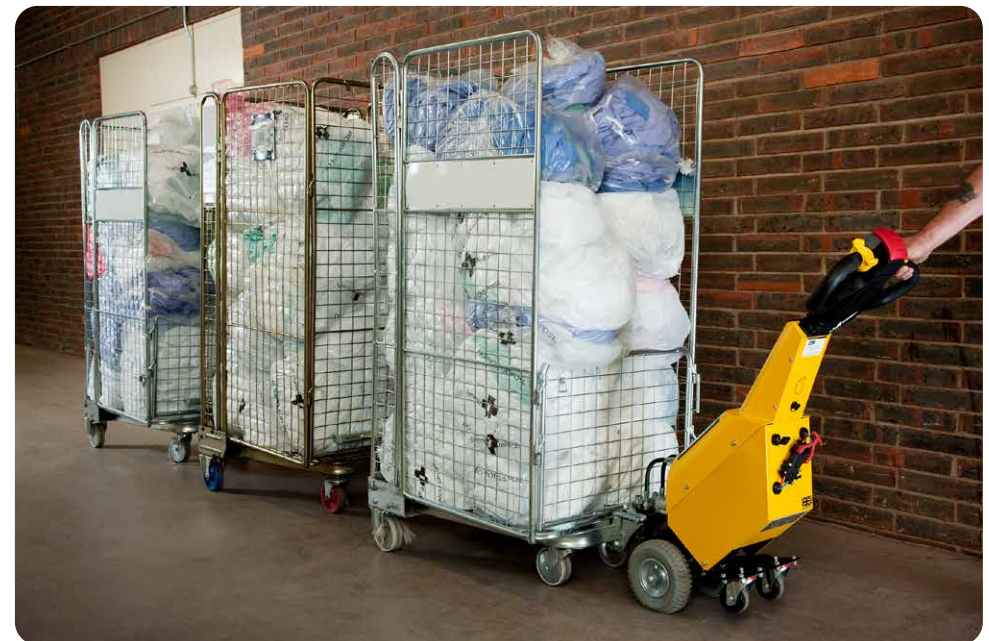

Industries

# Food & Beverage





# Eliminating manual handling in the food industry



Factory managers are constantly seeking out new ways to make their operations more efficient and safer.

Food and beverage manufacturers choose electric tugs to manage production flow and eliminate manual handling – maximising efficiency and reducing the risk of injuries.

## Typical applications:

- Hoppers
- Eurobins & totes
- Production machinery
- Ovens

## Benefits for food manufacturing



Eliminate manual handling



Improved safety



Boost productivity



Meet hygiene standards





Industries

# Manufacturing & Assembly





# Driving safety and efficiency in manufacturing

Electric tugs are helping industrial manufacturers across the globe cut downtime, improve safety and increase both operational efficiency and flexibility.

Whether it's in eliminating manual handling in glass manufacturing or reducing turnaround times in rail maintenance, electric tugs are relied on to drive safety and efficiency.

## Typical applications:

- Stillages
- Moulds
- Lamination trolleys
- Bogies
- Kiln cars
- A-frame carts

## Benefits for industrial manufacturing



Improve safety



Drive efficiency



Precise movements



Maximum manoeuvrability



Industries

# Retail, Logistics & Warehousing





# Optimising efficiency from fulfilment to delivery

Optimising material handling processes is a key focus for many retail, logistics and warehouse companies.

Further fuelled by rising demand and labour shortages, retailers are increasingly adopting electric tugs to improve safety and maximise operational efficiency.

## Typical applications:

- Roll cages
- Nested cages
- Fulfilment tow trains
- Picking trolleys

## Benefits for industrial manufacturing



Eliminating manual handling



Improving efficiency



Reducing accidents



Boosting productivity



Industries

# Pharmaceutical & Life Sciences





# Achieve safe, controlled movements of sensitive loads and equipment



For pharmaceutical manufacturers, stainless steel electric tugs allow process staff to safely manoeuvre heavy, high-value cleanroom equipment, eliminating manual handling and maximising production efficiency.

From buffer totes to chromatography columns, electric tugs help maximise suite uptime and speed up changeovers without compromising on safety.

## Typical applications:

- Chromatography columns
- Media & buffer totes
- Single-use mixers
- Tanks & reactors

## Benefits for pharmaceutical & life sciences



Improve workplace safety



Maximise suite uptime



Unlock greater flexibility



Cleanroom-ready



# See our electric tugs in action...

If you'd like to see and explore how our electric tug solutions could benefit your operation, talk to us about:

- A visit to an existing customer
- A demonstration at MasterMover
- An on-site demonstration

Get in touch with our team today...

**[mastermover.com](http://mastermover.com)**

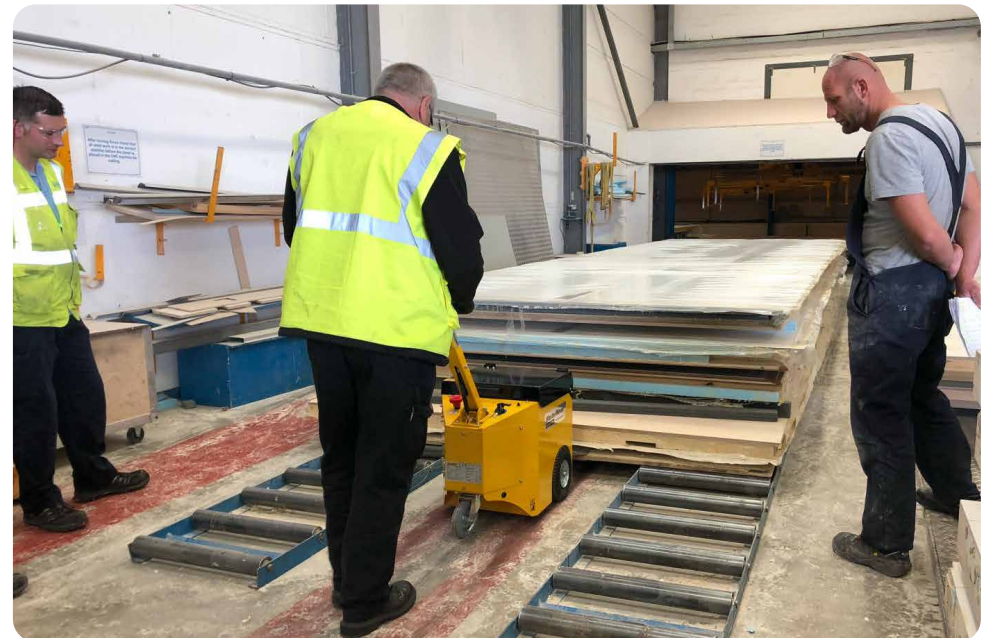



# Safer movements for Volkswagen

## Before

- Manual movements of body-in-whites led to a high risk of injury
- Staff taken away from value-adding tasks to manually move loads
- Difficulty positioning loads in test bays

## Now

- Using an MT400+ to eliminate manual handling
- Increased efficiency and labour productivity
- Precise positioning of body-in-whites in tight testing bays



# Testimonials

“MasterMover are easy to work with and all products performed as advertised. Moved our heavy products with ease!”

**Parker Maccianti, Mechanical Engineer**  
Bell-Everman

“The tugs have enabled us to change the way we produce our units making the workshop a more efficient and a safer environment.”

**Steve Griffiths, Depot & Production Manager**  
Select Plant Hire

“Since we introduced MasterMover’s electric tugs, we have never looked back! Their equipment revolutionised the way we handle heavy goods.”

**Akiva Brunner, Property Manager**  
BRNS Group

# Custom Solutions

## Custom solutions for turnkey systems or small modifications

Whether it's a custom coupling to connect to your load, modifying our electric tugs to work in a challenging environment, or designing an entirely new solution for your application, our Customer Engineering team can help.

We have a rich track record of delivering custom solutions, and in fact many of our product portfolio started as custom projects!

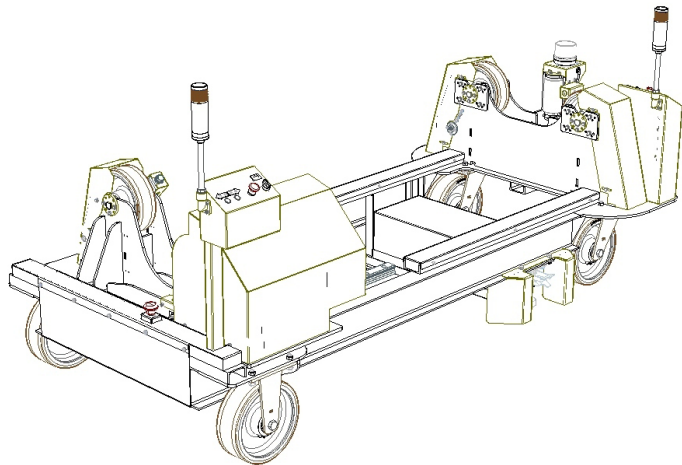

## Custom engineering

### In-house Engineering team

From consultancy right through to manufacture, our in-house Custom Engineering team work with you to understand your requirements and create a solution that delivers every time.



## Global support

### Here to help

Material handling equipment and moving heavy loads is what we do. Our team conceptualises and proposes ideas around your applications, enabling you to weigh your options and benefit from industry-leading advice.

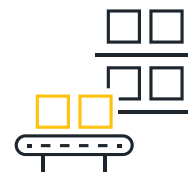

## Staged design

### Robust processes

Unique requirements and custom solutions need to be thought through. With a robust 4-step process in place, we work with you every step of the way, ensuring your needs are understood and met.





# Innovation at our core

## Driving load moving forward...

As pioneers of electric tug solutions we continue to push the material handling industry forward through innovation.

## Automated Guided Vehicles (AGV)

Benefit from safe load movement with the added benefit of fully autonomous operation with our AGV electric tugs.

## MultiLink Technology

MultiLink technology enables multiple PowerSteered electric tugs to work in synchronisation, under the control of one operator.

## Unrivalled load capacity

We continue to lead the way when it comes to load capacity. With solutions to move up to 70,000kg and beyond, you're in safe hands.

# Service & Support

## Global technical support

MasterMover has a global technical support team, alongside a global network of service partners, to ensure peace of mind when using any of our machines. Our Technical Support team is on-hand to provide fast, helpful support with questions, breakdowns, approved parts, warranty and servicing.

## Approved parts

Manufacturer-approved parts for quality assurance. By using genuine MasterMover parts, you benefit from guaranteed compatibility and superior quality, maximising your electric tug's service life and performance.

## Rental options

Whether you need short-term hire to meet increased demand, or a long-term contract hire agreement, our electric tug rental options can be designed around you.

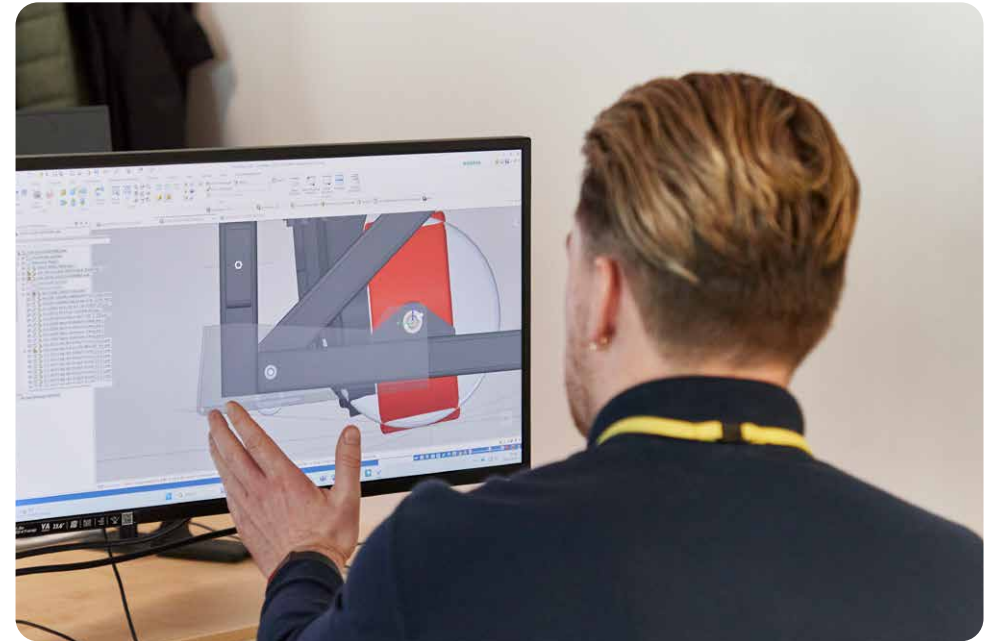



About MasterMover

# Compact solutions to safely and efficiently move products, equipment and materials.

MasterMover material handling solutions help people easily move heavy or large loads, while improving safety and operational efficiency in organisations around the world.

**MasterMover®**



mastermover.com



Engineered  
innovation.  
Performance  
guaranteed.

**MasterMover®**

[mastermover.com](https://mastermover.com)